

ATTRACTIVE 1/48 3D PRINTED SET BY SPECIAL HOBBY

P48014
1/48
**SMB-2 Super Mystere
Ladder (IAF type)**
for Special Hobby kits

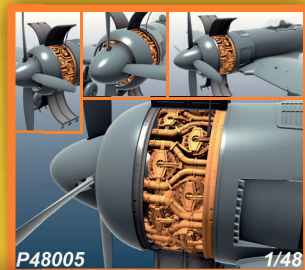
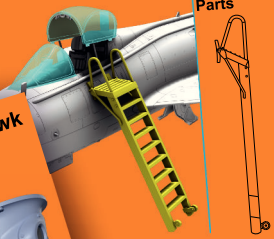

P48005
1/48
Tempest Mk.II Engine
(Continental O-170-3)

3D printed parts and resin parts.
Recommended for Special Hobby kits.

P48026
1/48
**P-40E Warhawk/Kittyhawk
Gun Cine Camera**
(2 pcs.)

3D-Printed Parts
1 2 3
2x

P48002
1/48
L-4 Grasshopper Engine
(Continental O-170-3)
for Special Hobby kits

3D-Printed Parts
PP3 PP4 PP1 PP2



P48025
1/48
**Heinkel He 115B
Engines**

Set contains two BMW 132 engines with open covers
as 3D printed parts. Recommended for SH kits.



4495
1/48
Lysander Mk.III (SD)
Conversion set

Set contains 3D printed parts and decals
for four camouflage versions



facebook.com/specialhobby
WWW.SPECIALHOBBY.EU



Highly detailed 3D printed set
for Airfix kit

4497
1/48

Lysander Mk.II (Perseus Engine)

Conversion Set

Visit our official website and e-shop at
www.cmkkits.com
www.specialhobby.eu

3D-Printed Parts www.facebook.com/specialhobby

3D 1 3D 2 3D 3 3D 4 3D 5 3D 6
3D 7 (3x) 3D 8 3D 9 3D 10
3D 11 (2x) 3D 12
3D 13 3D 14 (2x)

Decals

L476I L4809
L476I L4809
AN B KJ H
AN B KJ H
416 416
NI256 X M M
NI256 416 416
4497 Sheet A
Lysander Mk.II
4497 Sheet B
Lysander Mk.II

Resinové díly ohnuté popř. pokroucené vlivem teplotních změn a stárnutí materiálu, mohou být narovnány do požadovaného tvaru pomocí proudu teplé vody nebo vzduchu (fén na vlasy). Ohnuté 3D tisky narovnejte ponořením do horké vody, srovnajte je a zchladte studenou vodou. K lepení použijte kyanoakrylátové lepidlo! Kontaktní plochy doporučujeme před lepením odmastit. Různé drátky a tyčinky nejsou přiloženy.

Parts slightly distorted and bent owing to temperature changes or due to material aging can be straightened to requested shape by hot water or hot air jet (hair dryer). This process can be repeated till result is entirely satisfactory. You can also correct bent 3D printed parts: put them into hot water, straighten them and cool them in cold water. For best result use cyanoacrylate glue! Ungreasing contact areas is recommended before gluing. Wires and rods not included.

MOŽNOST VOLBY OPTIONAL NACH BELIEBEN OPTION	POUŽÍJTE KYANOAKRYLÁTOVÉ LEPIDLO INSTANT CYANOACRYLATE GLUE ZYANOAKRYLATKLEBER ADHESIF CYANOACRYLAT	OHNOUT BEND BIEGEN COURBER	ZHOTOVIT NOVÉ SCRATCH BUILD FERTIGSTELLEN ACHEVER	ŘEZAT/VRTAT CUT OFF/DRILL ENTFERNEN DETACHER	GSI colours code NATRÍT COLOUR FARBEN PEINDREN
--	--	-------------------------------------	--	---	---

Producer: Special Hobby, Mezilesí 718, 193 00 Praha 9, Czech Republic

Scheme A

L4761 AN-B, No.13 (army co-op) Sqn, RAF Odiham, Hampshire, England, April 1939.

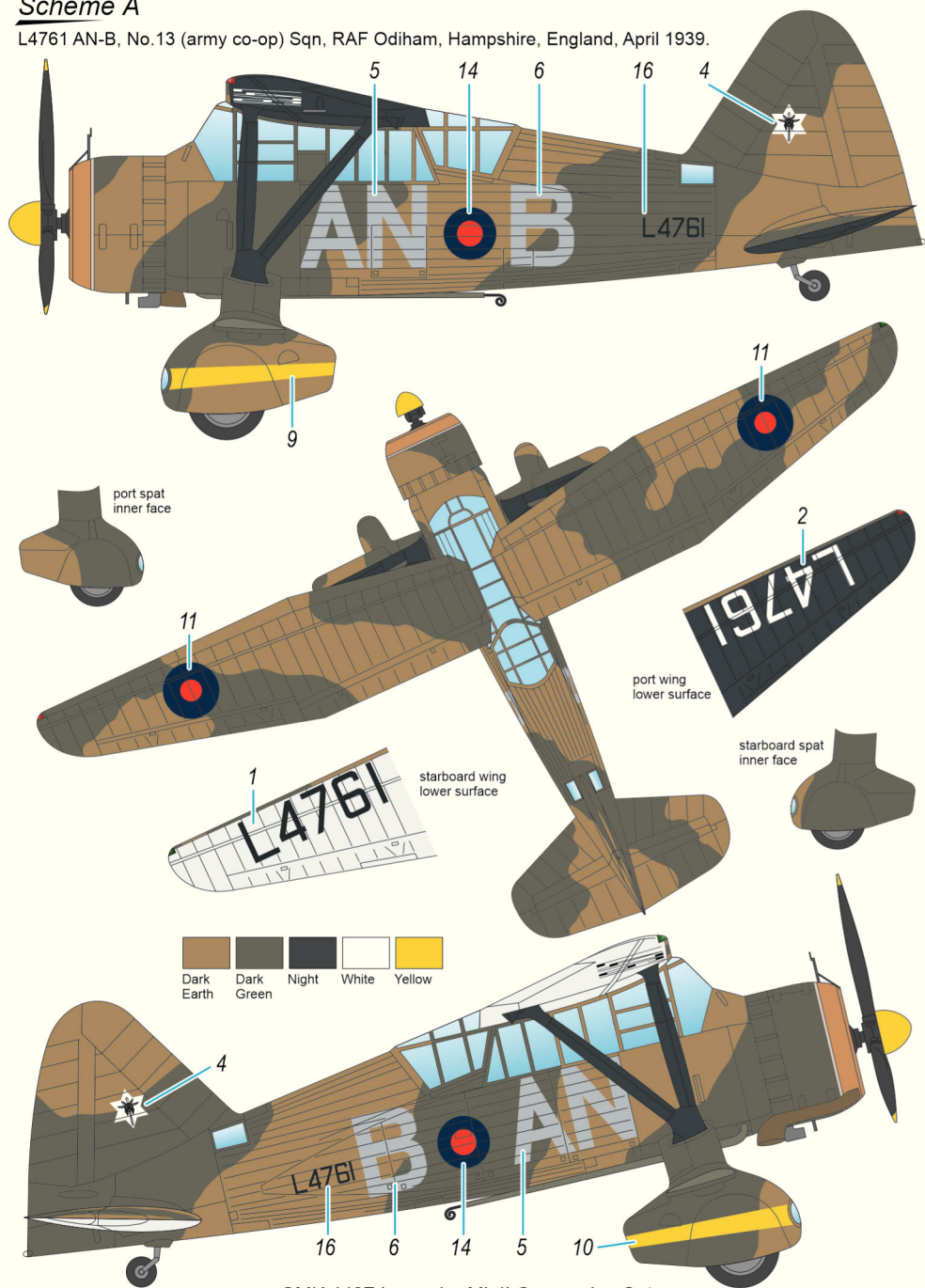

CMK 4497 Lysander Mk.II Conversion Set

Scheme D

s/n 416 TM-A, No.111 Sqn, RCAF Station Patricia Bay, British Columbia, Canada, January 1941.

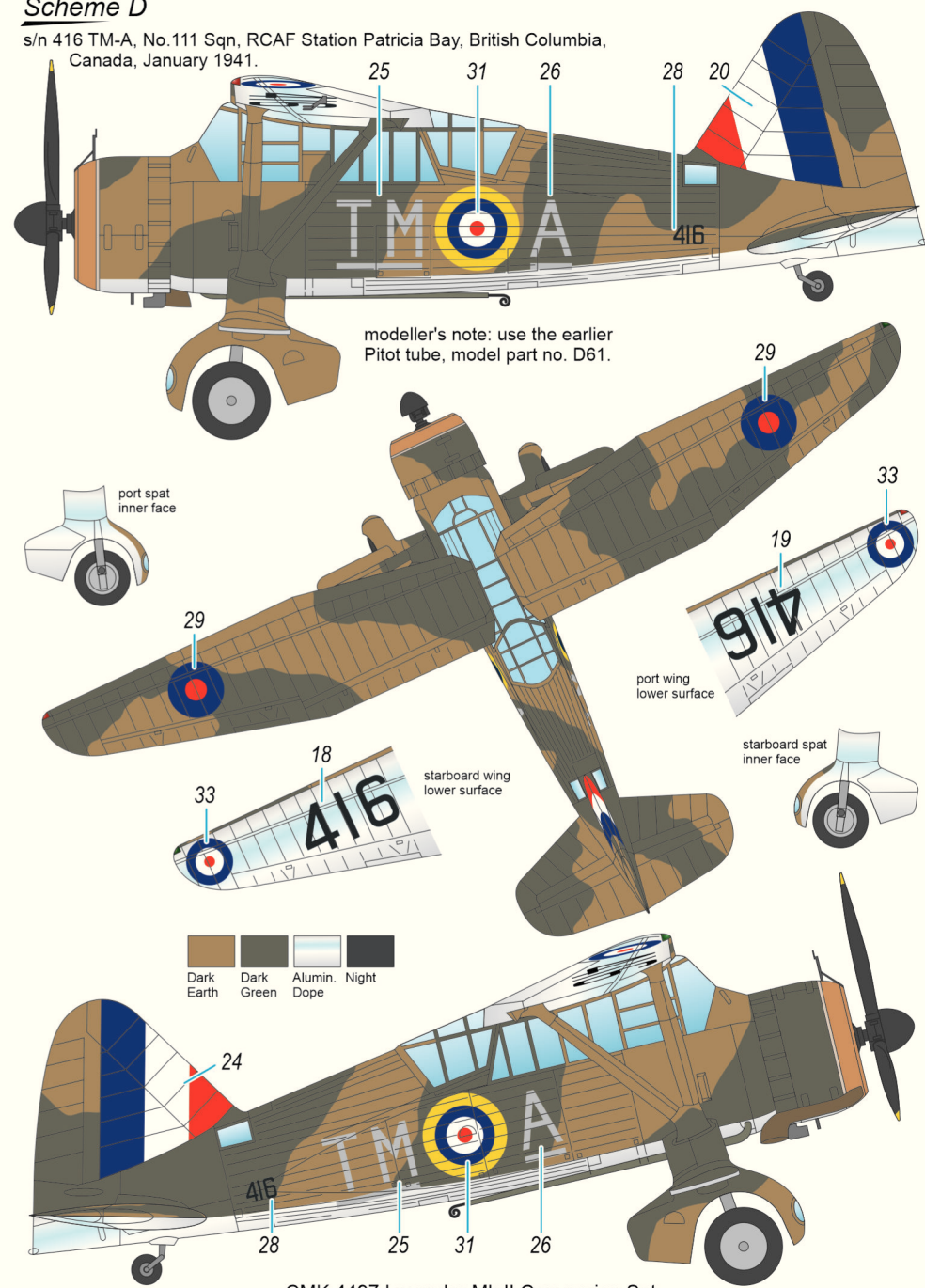

CMK 4497 Lysander Mk.II Conversion Set

Scheme C

N1256 LX-M, No.225 Sqn, RAF Odiham, Hampshire, England, mid-1940.

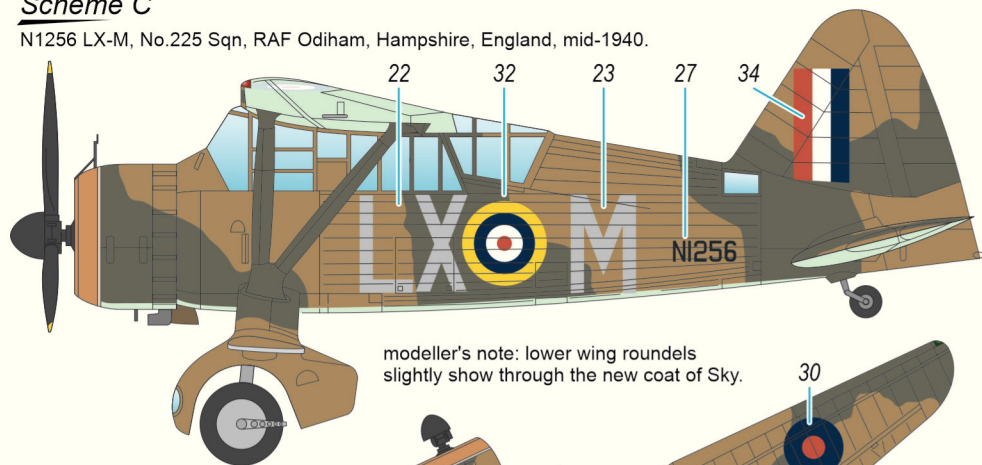

modeller's note: lower wing roundels slightly show through the new coat of Sky.

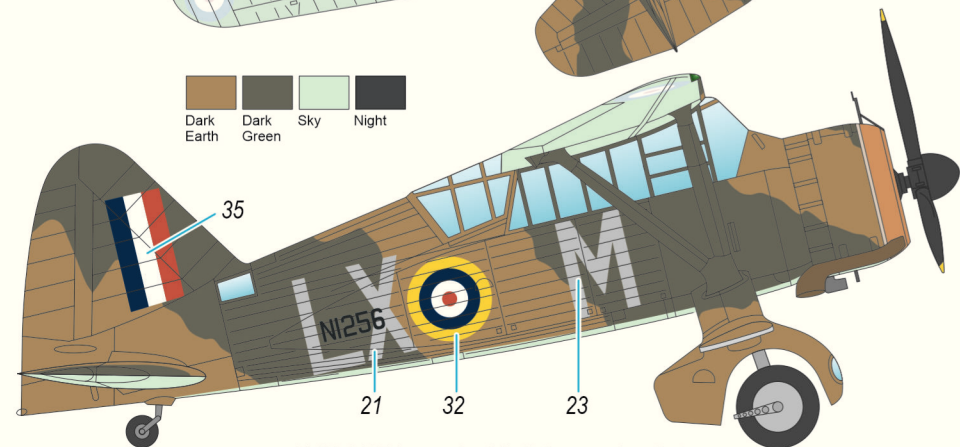
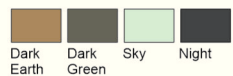
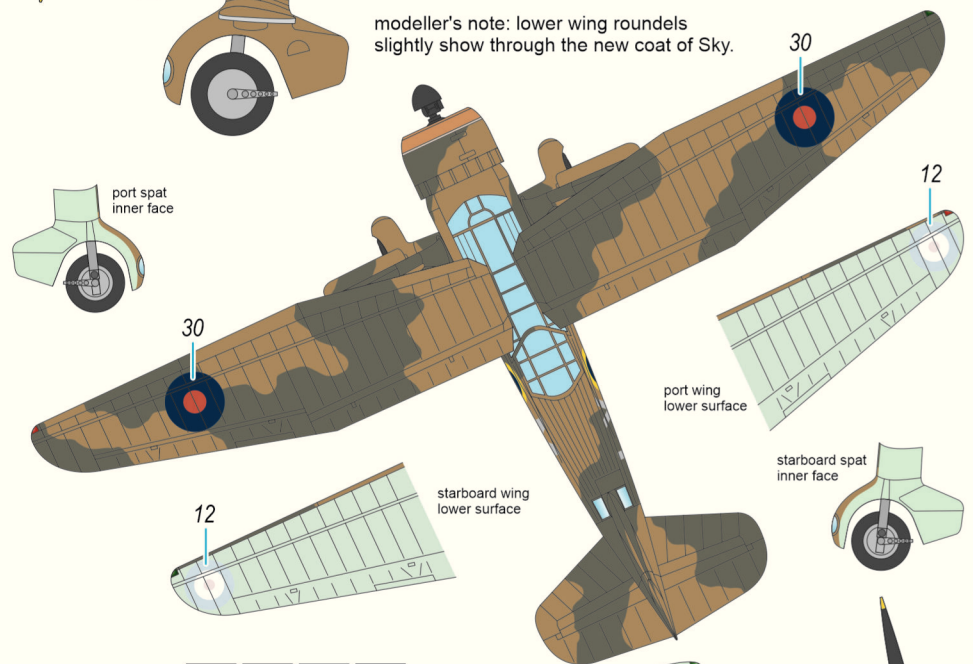

CMK 4497 Lysander Mk.II Conversion Set

Scheme B

L4809 KJ-H, No.16 (army co-op) Sqn, RAF Old Sarum, Wiltshire, England, May 1939.

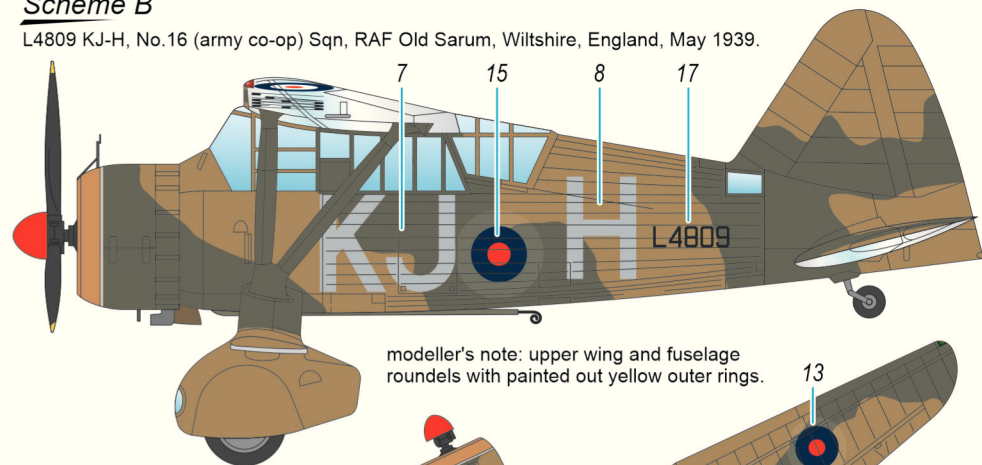

modeller's note: upper wing and fuselage roundels with painted out yellow outer rings.

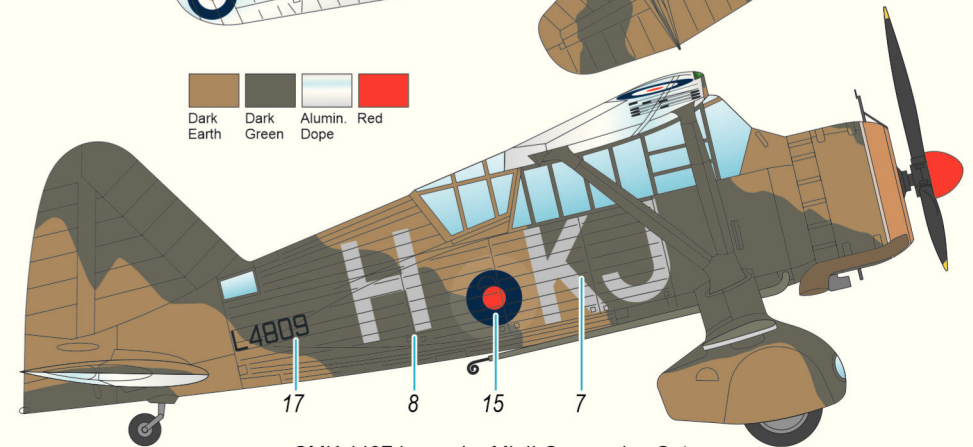
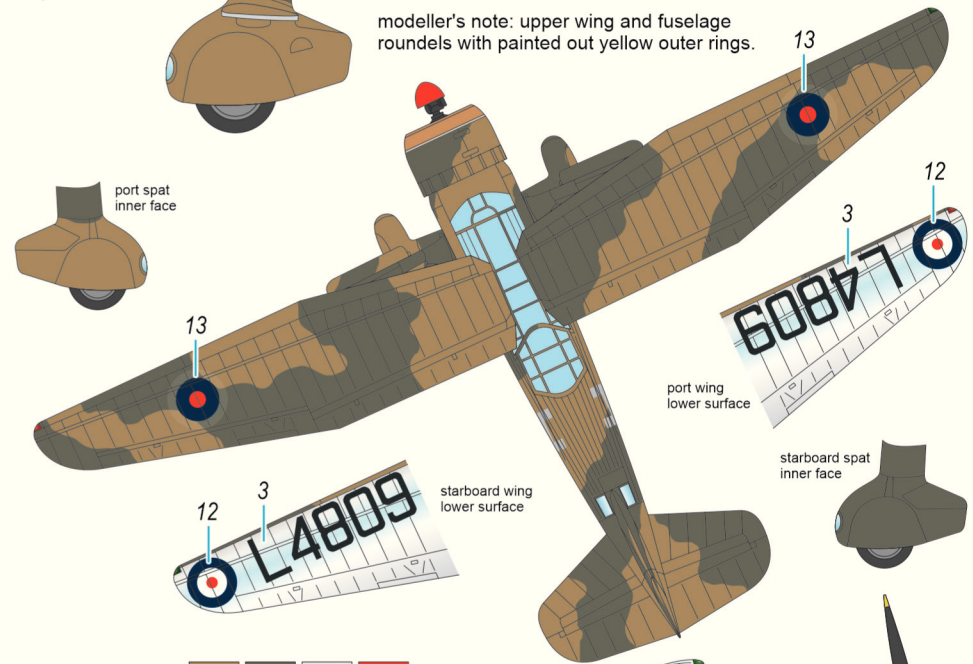

CMK 4497 Lysander Mk.II Conversion Set

Step 1

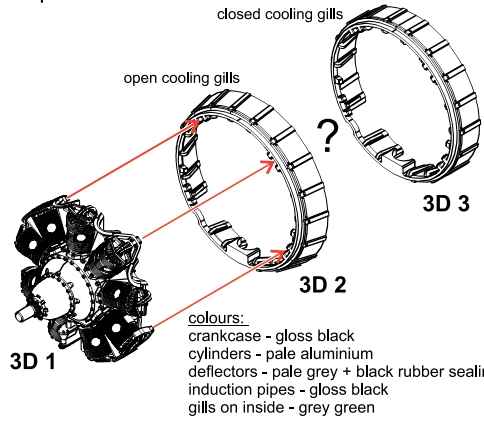

Step 2

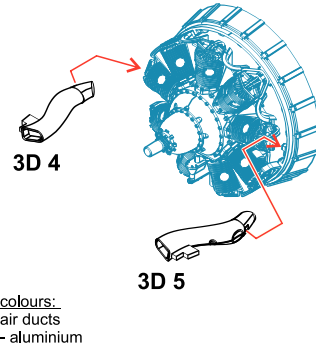

Step 3

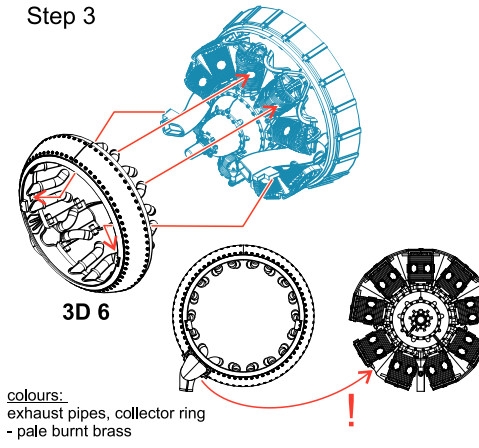

Step 4

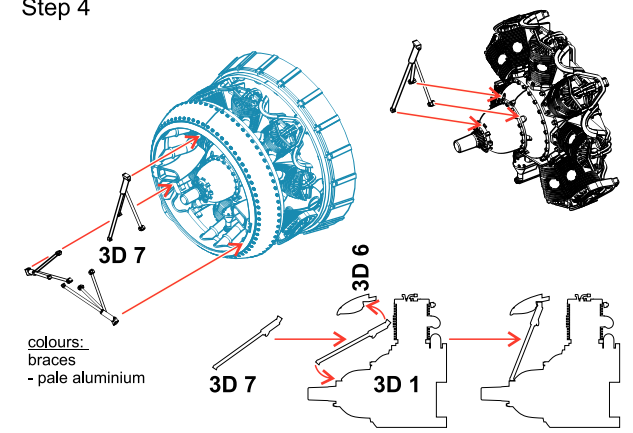

Step 5A

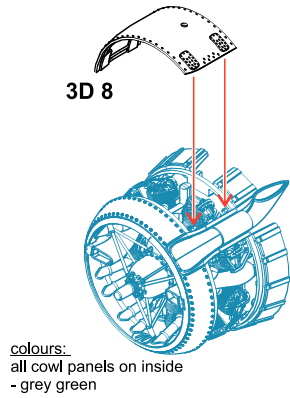

Step 5B

(when top / stbd cowl panels removed)

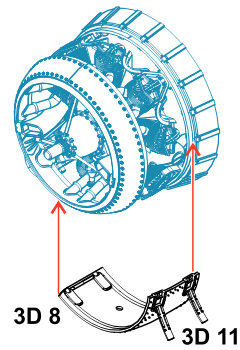

Step 6

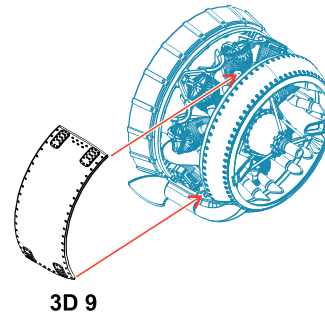

Step 7

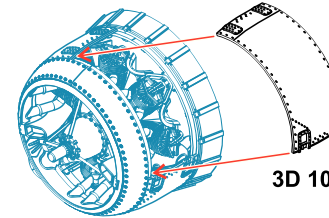

Step 8

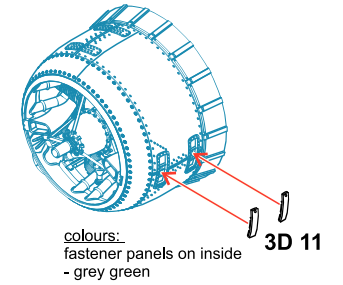

Step 9

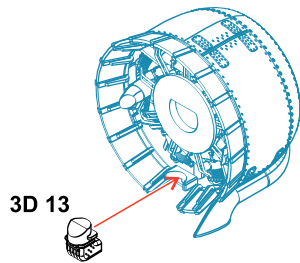

colours:
carburettor air intake
- gloss black / pale aluminium / camouflage colour

Step 10A

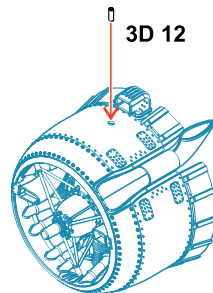

Step 10B

(when bottom cowl panel removed)

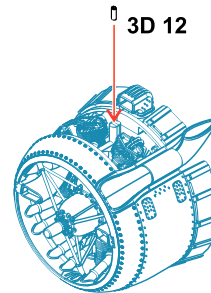

Step 11

