

DAP Beaufighter Mk.21, DU-A/ A8-27, named Rockabye Baby, Morotai, 1945.

DAP Beaufighter Mk.21, DU-A/ A8-27, Rockabye Baby, Morotai, 1945

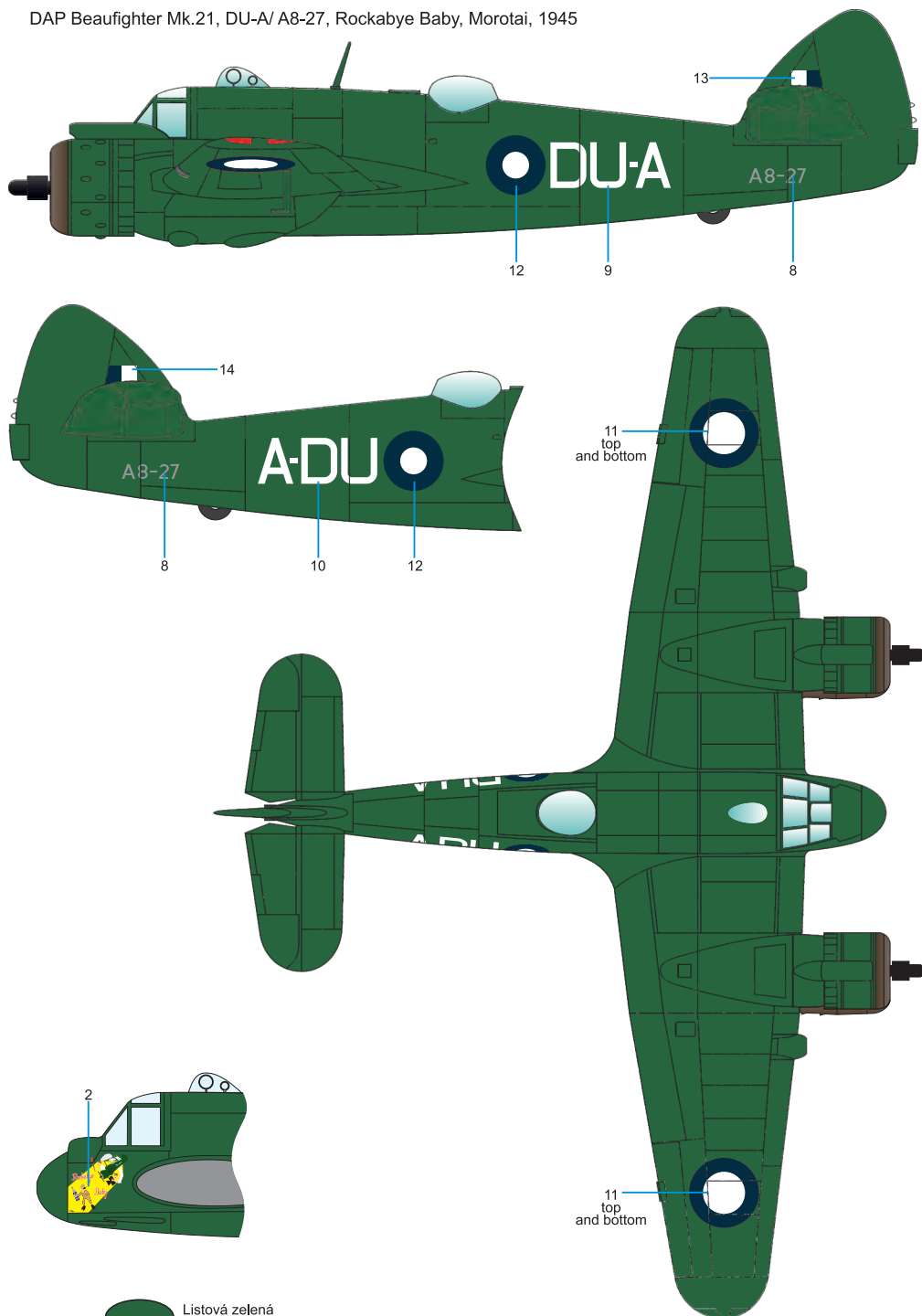

 Listová zelená  
Foliage Green



Odlévaný set / All resin set

**4406**  
**1/48**

**Beaufighter Mk.21 Conversion Set**

for Revell kit

Visit our official website and e-shop at [www.cmkkits.com](http://www.cmkkits.com)  
[www.specialhobby.eu](http://www.specialhobby.eu)

**PUR - Polyurethane parts**

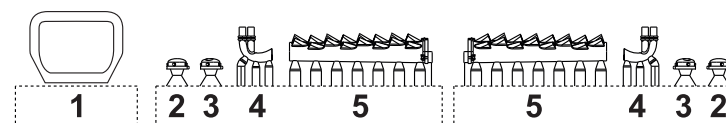

**CP - Clear parts**

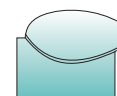

CP1



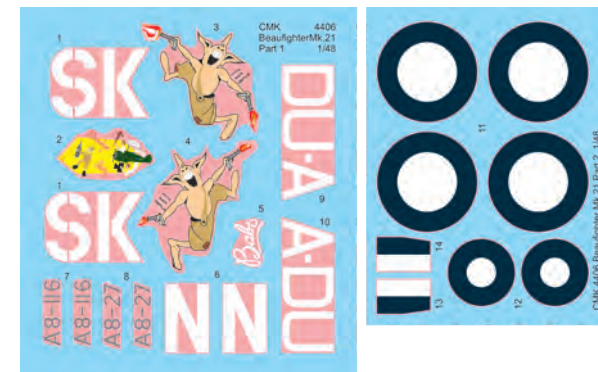



**Decal**



Díly ohnuté popř. pokroucené vlivem teplotních změn a stárnutí materiálu, mohou být narovnané do požadovaného tvaru pomocí proudu teplé vody nebo vzduchu (fén na vlasy). Různé drátky a tyčky nejsou přiloženy. Kontaktní plochy doporučujeme před lepením odmastit.

Parts slightly distorted and bent owing to temperature changes or due to material ageing can be straightened to requested shape by hot water or hot air jet (hair dryer). This process can be repeated till result is entirely satisfactory. Wires and rods not included. It is recommended to remove grease from contact areas

K lepení použít kyanoakrylátové lepidlo / For best gluing results use cyanoacrylate glue!

SYMBOLS					
	MOŽNOST VOLBY OPTIONAL NACH BELIEBEN OPTION		POUŽIT KYANOAKRYLÁTOVÉ LEPIDLO INSTANT CYANOACRYLATE GLUE ZYANOAKRYLATKLEBER ADHÉSIF CYANOACRYLAT		OHNOUT BEND BIEGEN COURBER
	ZHOTOVIT NOVĚ SCRATCH BUILD FERTIGSTELLEN ACHEVER		ŘEZATÍ/VRTAT CUT OFF/DRILL ENTFERNEN DETACHER		NATŘÍT COLOUR FARBEN PEINDRE

Producer: Special Hobby, Mezilesí 718, 193 00 Praha 9, Czech Republic

**STEP 1**

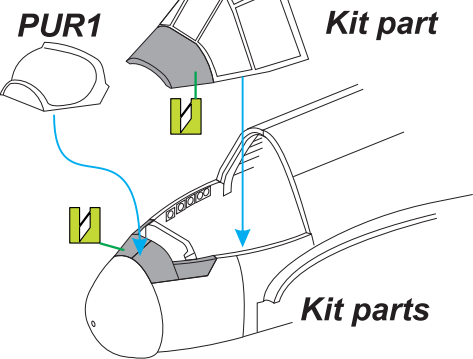

**STEP 2**

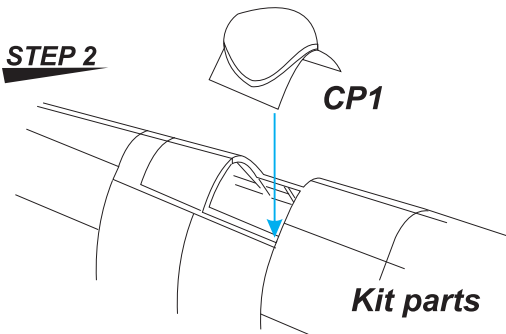

**STEP 3**

**2x**

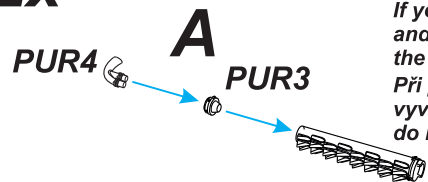

If you use the exhaust with heating (pieces PUR3 and PUR4), drill a hole into the engine nacelle where the end of PUR4 enters it.  
 Při použití výfuku s topením (s díly PUR3 a PUR4) vyvrtejte v místě vstupu zakončení dílu PUR4 otvor do motorové gondoly.

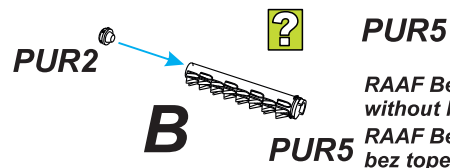

RAAF Beaufighters MK.21 used mostly exhausts without heating (PUR2).  
 RAAF Beaufightery Mk.21 častěji používaly výfuky bez topení (PUR2)

**STEP 4**

**2x**

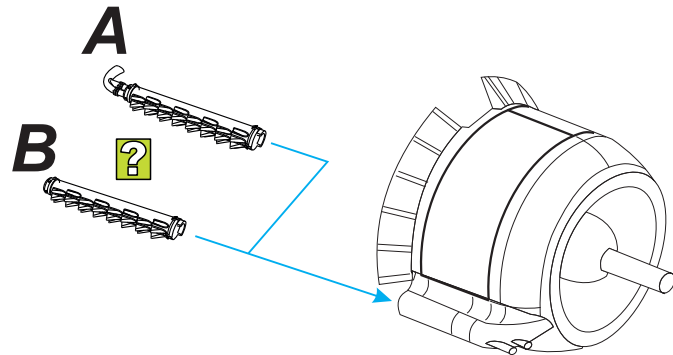

DAP Beaufighter Mk.21, SK-N/ A8-116, dubbed Babs / Pistol Pakin Gremlin, No.93 Sqn. RAAF, crew W/O L.W. Mutton and F/S C.G.Curthoys, Labuan, Borneo, August 1945.  
 DAP Beaufighter Mk.21, SK-N/ A8-116, pojmenovaný Babs / Pistol Pakin Gremlin, No.93 Sqn. RAAF, osádka W/O L.W. Mutton a F/S C.G.Curthoys, Labuan, Borneo, srpen 1945.

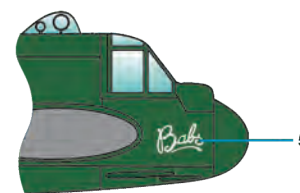
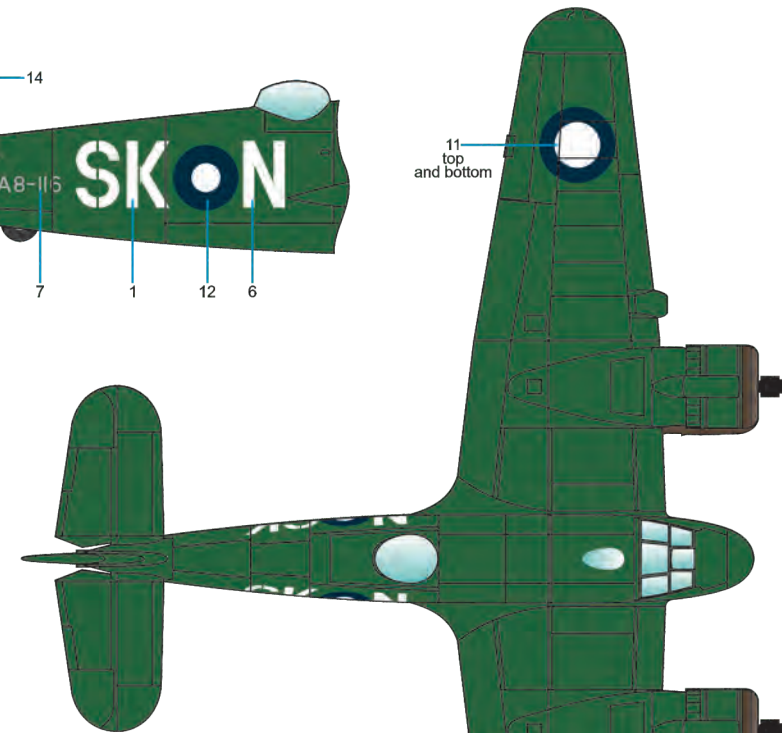
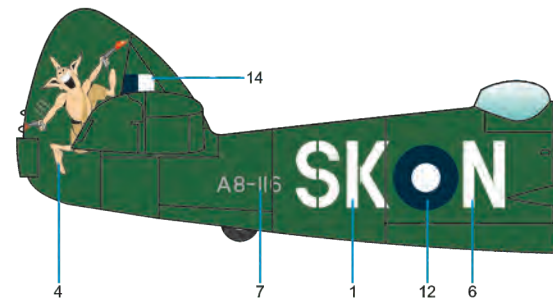
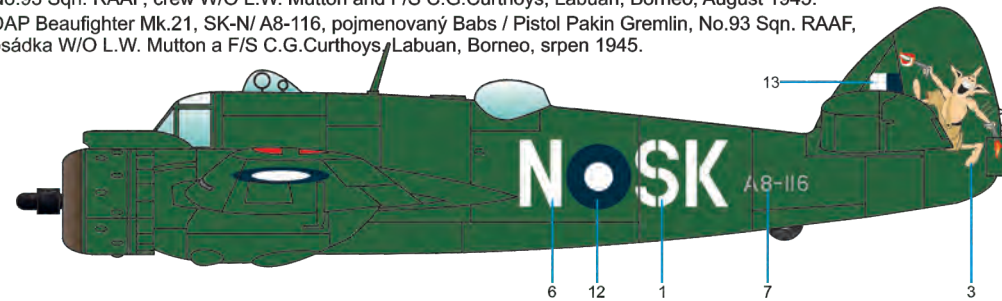

Listová zelená  
 Foliage Green